



MASTODON

FORESTRY MULCHERS



OPERATING MANUAL

M60-S
Copyright 2025

Delivery Record

Please Keep & Forward Copy

The checklist is a reminder of very important information that should be conveyed to the customer at the time the unit is delivered. Check off each item as it is explained to the customer.

- Dougherty Forestry Manufacturing warranty.
- Safe and correct operation and service.
- Daily and periodic inspections.
- Servicing machine regularly and correctly.
- Explain proper mulching procedures.
- Give the Operator's Manual to the customer and encourage customer to read entire manual.
- Advise customer of safety precautions that must be observed while using a Mastodon mulcher
- Review information on how to maintain a Mastodon Mulching head (See Maintenance section.)
- Review recommended procedures for attaching to or detaching from carrier (See Attaching and Detaching section.)
- Review equipment safety features
- Review carrier operation. (See basic operation)
- Review service intervals and lubrication points. (See Lubrication and Maintenance section.)
- Review all adjustments.
- Have customer record machine serial number in the Introduction section.
- Dougherty Forestry parts and service.
- Remove and file this page.

DATE DELIVERED _____ SIGNATURE _____

Contents:

About.....	Page 4
Warranty.....	Page: 5
Overview.....	Page: 6
Maintenance.....	Page: 7-11
Foreword for Operating Mulcher	Page: 12
Safety.....	Page: 13-14
Setup.....	Page: 15-16
Smart Drive.....	Page: 17-22
Operation.....	Page: 18-29
Troubleshooting.....	Page: 30

About the Manual:

This manual is intended as a basic outline for safely operating t Mastodon vegetation cutting attachments, the practices within this manual are intended as a reference, and are not to be a substitute for conventional safety practices. DFM assumes no liability for any damage to persons or property as a result of misuse of its products. DFM assumes no liability for damage to persons or property due to lack of adherence to conventional safety practices common in the field of forestry mulching. The owner/operator assumes all liability when operating this product in its intended use as outlined buy this manual. The Owner/Operator of this product is strongly discouraged from operating this product outside of its intended use as outlined by this manual. DFM encourages the owner/operator to fully read and understand this manual before attempting to use this product. The owner/operator should be aware of all risks in the forestry and land clearing industries before using this product.

Overview:

Mastodon mulching heads are Skid Steer/Compact Track Loader compatible rotor based mulching attachments, designed to fully cut and process trees and woody vegetation up to 12”+ in diameter. The attachment consists of a mounting plate, a frame, a reinforced pushing bar, a cutting rotor, 2 rotor bearing blocks, a piston hydraulic motor, a ECU Smart-Drive M60-S a hydraulic debris door (M60-C), 2 hydraulic hoses, one case drain hose, and rear safety chains.

2 Component Warranty Policy

A. GENERAL PROVISIONS – The warranties described below are provided by Dougherty Forestry Manufacturing (“DFM”) to the original purchasers of new Tree Clearing Equipment from DFM or authorized DFM dealers. *Warranty begins on the date of product delivery to the original purchaser. Warranty coverage for units used in rental applications is for a 90 day period which begins upon first date of rental.* Under these warranties, DFM will repair or replace, at its option, any covered part which is found to be defective in material or workmanship during the applicable warranty term. Warranty service must be performed by a dealer or service center authorized by DFM to sell and/or service the type of product involved, which will use only new or remanufactured parts or components furnished by DFM. Warranty service will be performed without charge to the purchaser for parts or labor. The purchaser will be responsible, however, for any service call and/or transportation of product to and from the dealer’s or service center’s place of business, for any premium charged for overtime labor requested by the purchaser, and for any service and/or maintenance not directly related to any defect covered under the warranties below. *All claims for this warranty policy must be accompanied by a copy of the original sales receipt and must be made to Dougherty Forestry manufacturing in writing within eight (8) days after the occurrence. Any claim after the eight (8) days will automatically invalidate the warranty claim.* **COMPONENTS COVERAGE:**

Dougherty Forestry Manufacturing offers a twenty four (24) month warranty from date of purchase by the original purchaser. Components may also be warranted by their original manufacturers which may vary from this warranty. Coverage has the following exclusions: The original purchaser is responsible for and must bear the cost of: Normal maintenance of the machine such as greasing, minor adjustments, etc. transportation of defective part(s) to and from Dougherty Forestry Manufacturing or such place where warranty work is being performed. This warranty does not cover any damage to the machine the DFM product is attached to nor subjected to falling trees or limbs, flying debris, hydraulic component damage.

B.Warranty Coverage: All metal housing, fabrication, and components of any new DFM product against manufactured defects and workmanship.

C.Non-Warranty Coverage: DFM is not responsible for the following: (1) Used Products: (2) Any product that has been altered or modified in ways not approved by DFM (3) Depreciation or damage caused by normal wear and tear, lack of reasonable and proper maintenance, failure to follow operating instructions, damage due to improper use, abuse or neglect or conditions caused by abuse or neglect, misuse, lack of proper protection during storage, or accident (4) Normal maintenance parts and service. **This warranty does not cover normal wear items. Such items would include, but not be limited to: teeth, carbide inserts, holders, bolts in wear areas, bearings or seals.**

D.SECURING WARRANTY SERVICE – To secure warranty service, the purchaser must (1) Report the product defect to an authorized representative and request repair within the applicable warranty term, (2) Present evidence of the warranty start date and (3) Make the product available to the dealer or service center within a reasonable period of time.

G. Limitation of implied warranties and other remedies: DFM’s Tree Clearing Equipment, to the extent permitted by law, neither DFM nor any company affiliated with it makes any warranties, representations or promises as to the quality, performance or freedom from defect of DFM’s Tree Clearing Equipment covered by this warranty. Implied warranties or merchantability and fitness for a particular purpose, to the extent applicable, shall be limited in duration to the applicable period of warranty set forth on this page. The purchaser’s only remedies in connection with the breach or performance of any warranty on the DFM Tree Clearing Equipment are those set forth on this page. In no event will the dealer, DFM, or any company affiliated with DFM be liable for incidental or consequential damages. (Note: some states do not allow limitations on how long an implied warranty lasts or the exclusion or limitation of incidental or consequential damages so the above limitations and exclusions may not apply to you.) This warranty gives you specific legal rights, and you may also have other rights which vary from state to state.

H.No Dealer Warranty: The selling dealer makes no warranty of its own and the dealer has no authority to make any representation or promise on behalf of DFM, or to modify the terms or limitations of this warranty in any way

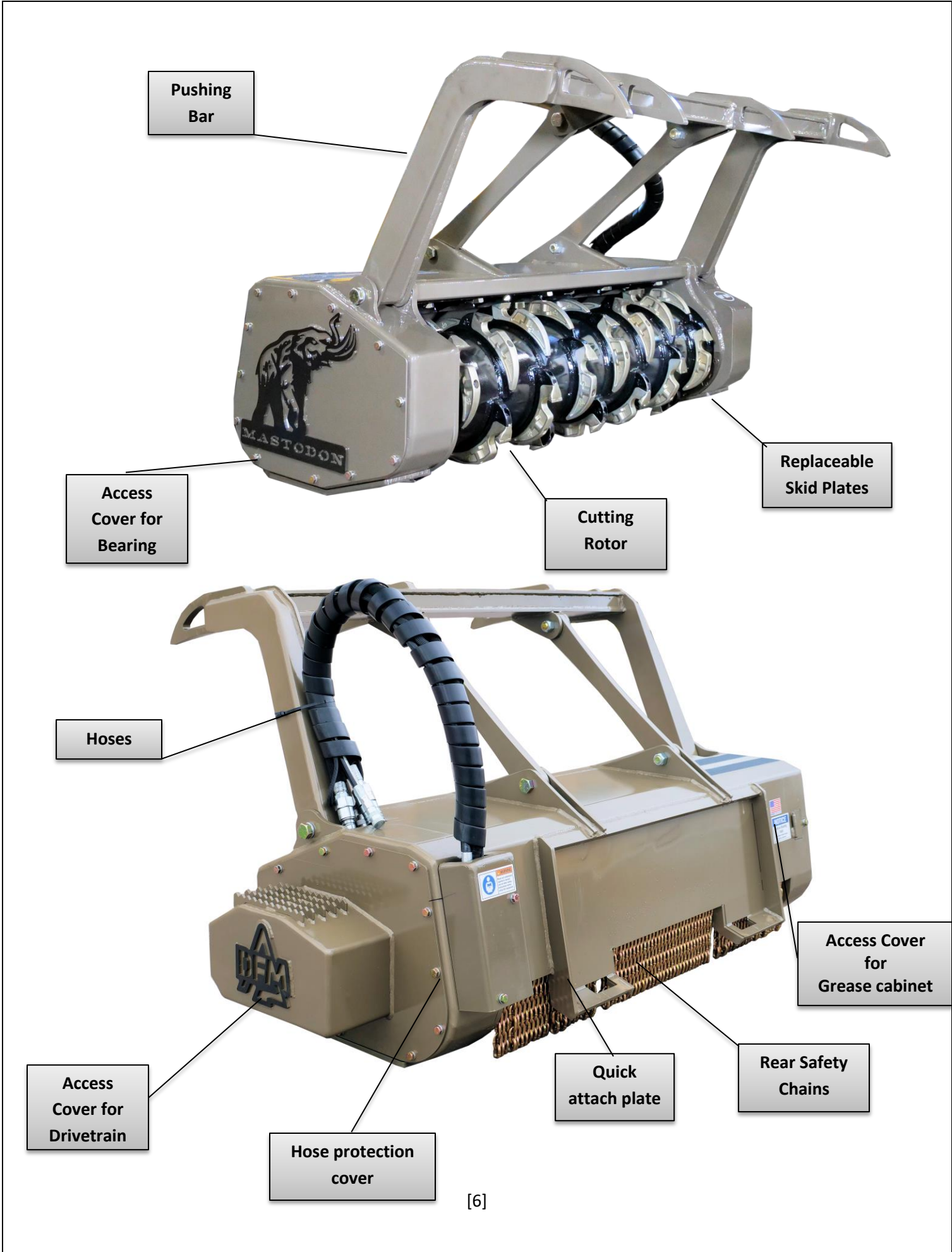

Safe Maintenance & Maintenance Schedule:

CAUTION Always Practice Safe Maintenance

Always work in a clean and dry environment. Never work on a running machine or on a machine with moving parts. Lower unit onto hard surface, disengage unit from carrier, engage brake, turn off carrier and remove key. Allow the unit to cool off before maintaining. Caution, parts may be hot, sharp, or hazardous. Follow guidelines on protective equipment and clothing.

*If you are not a licensed welder or hydraulic specialist call for maintenance assistance.

Beware of toxic fumes when maintaining your mulcher. Weld, smolder, or torch in a well ventilated area. Metal, paint, and other materials can be toxic when heated. Please be mindful of your chemical environment and wear the proper equipment when maintaining your mulcher such as a breathing mask and/or welders mask.

Always Perform Daily Inspection: Failure to inspect or maintain the mulcher daily may cause premature wear of components, resulting in component failure. Failure of components may result in damage to unit, and/or persons, and/or property. DFM accepts no liability on any damage to property or persons from failure to observe regular inspection and maintenance procedures.

Tools & Skill Requirements

Daily maintenance of your equipment requires basic tools, skill, and expertise.

Welding & hydraulic repair work should be done by a licensed professional. For a DFM

For maintenance specialist in your area please contact our service department at (405) 542-3520 or email contact@doughertymfg.com

Daily maintenance checklist:

- **Grease rotor bearings daily with lithium grease 10 pumps per 8 hours operated. (see fig 1)**
Note: The grease system comes with over grease prevention reliefs which prevent over greasing automatically.

Fig 1

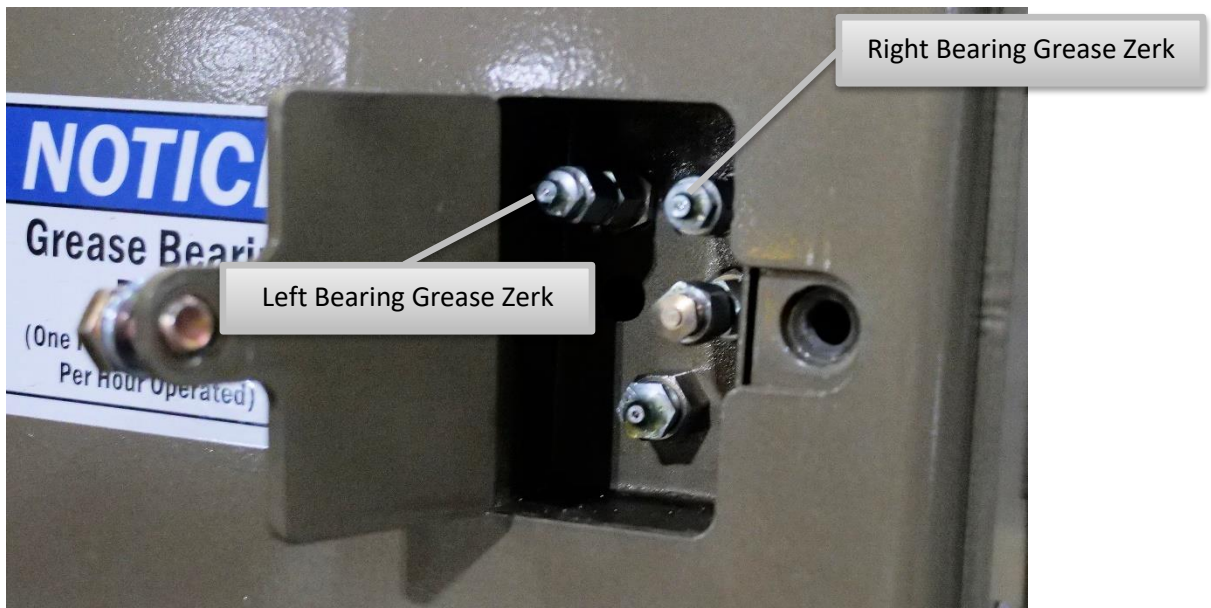
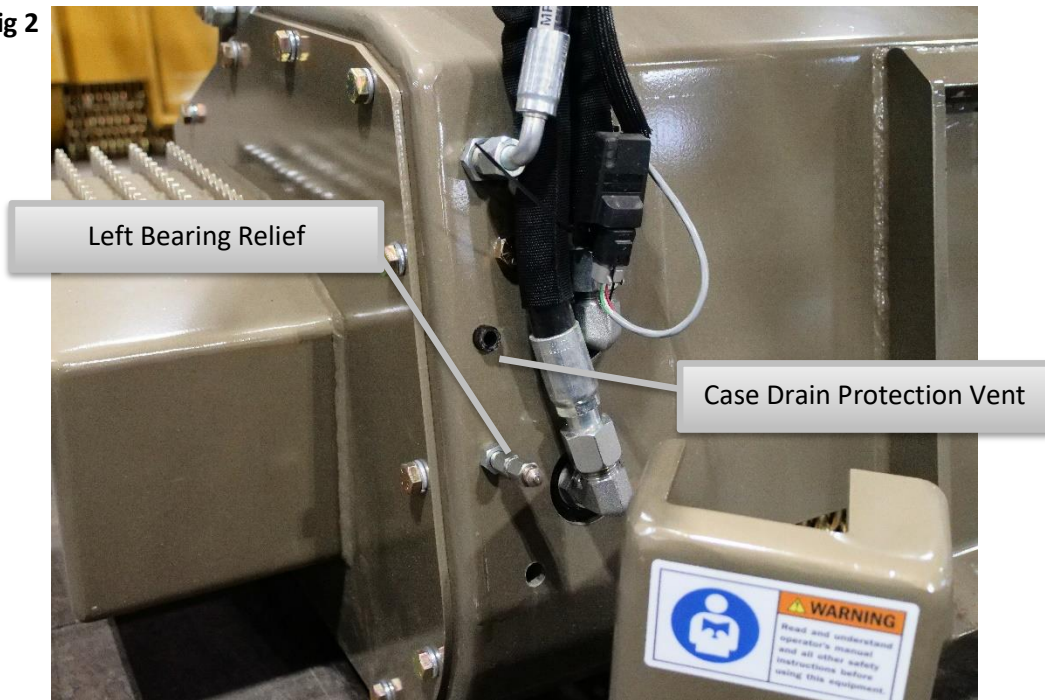

Fig 2



Note: The left bearing grease relief and the case drain protection vent are located on the left side (motor side) of the mulcher under the hose protection cover



- **Inspect all cutting teeth for tightness (tighten if necessary, to 100 ft-lbs.)**
- **Inspect under deck for excessive debris build up (clean if necessary)**
- **Inspect all hydraulic lines/couplers for leaks (replace if necessary)**
- **Check condition of carbide attachment backing blocks, if signs of wear are present contact service specialist.**
- **Start mulcher and check rotor for excessive vibration, vibration is an indication of bearing failure, rotor imbalance, or material buildup; if vibration is present remove anti wrap rings and fully clean out any foreign material from around rotor.**
- **If vibration is still present after cleaning contact your service representative and have machine serviced before continued use.**

Carbide Removal and Replacement:

Mastodon mulching heads utilize high strength double carbide teeth, designed for longevity and ease of replacement. The carbides are mounted to the rotor with two bolts that make use of lock washers.

In order to correctly replace a cutting carbide you will require the following:

- A 3/8" Allen Head Socket
- A long handled socket wrench/ impact wrench
- A anti-seize lubricant
- New Carbides
- New or reused bolts
- New or reused lock washers



Replacing Cutting Carbides

When first removing bolts from used carbides it may be necessary to unplug trapped wood debris from the Allen head hole on the bolt. A small regular head screw driver is recommended for this task.

With a 3/8" Allen head socket on a socket wrench or air impact, unscrew both holding bolts from the carbide holder.

When replacing carbide carefully inspect all the bolts and lock washer prior to remount. It is possible to reuse the bolts and washers but care must be taken to replace bolts and washers that will be unable to function properly. To extend the life of your bolt threads it is recommended that automotive anti-seize to be applied to the threads of the bolt each time they are replaced or reused. It is of vital to assemble all pieces of the carbide system in the right order with the rear bolt being tightened first.

Caution Tightening the front bolt first will result in the rear threads being damaged, please note the order in the picture below:

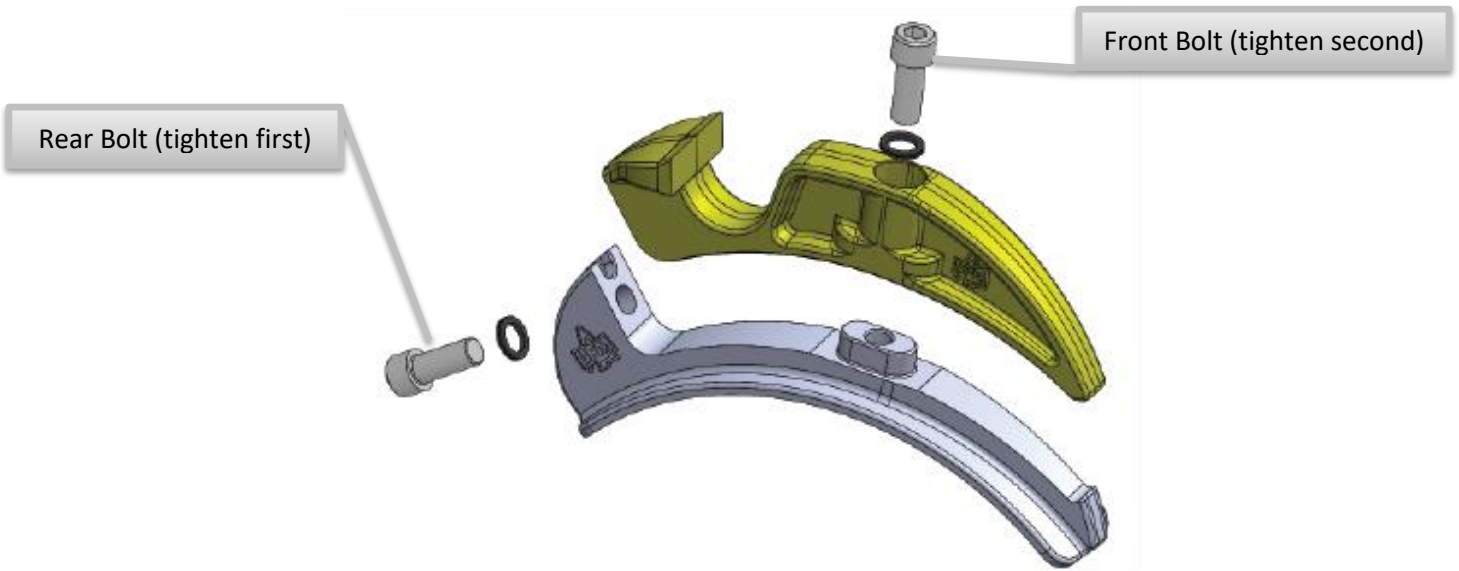

Once you are ready to remount the carbides start threading the bolts by hand to ensure that the bolt is not cross thread. Tighten bolts to **100 ft-lb**

Warranty policy: Due to the intended use of DFM products no warranty shall be provided for wear items and consumables.

Operating outside the products intended use will greatly increase wear and damage functionality. Never cut rocks, steel, scrap, or non-woody materials. Signs that your carbides have contacted foreign debris include:

- Carbides torn from holders
- Chips in the carbide
- Twisting teeth in holder
- Marring/gouging in teeth and holders.

Damage to the attachment in this manner may need the holders or possibly the entire rotor/holders to be replaced at the customer's expense.

FORWORD FOR OPERATING MASTODON FORESTRY

MULCHING ATTACHMENTS

Cutting brush and trees has inherent risks and hazards. To reduce those risks and hazards read the operator's manual, follow the safety precautions, and appropriately operate your mulching attachment. The methods and techniques in the operator's manual are designed to maximize your protection while mulching brush and trees. The Mastodon mulching heads are designed to cut trees and woody material only do not attempt to mulch anything outside of the mulchers intended use.

WAIT! Before starting your attachment, be familiar with your carrier & the attachment's basic operating controls. Each brand of carrier has unique operating controls that activate and utilize your mulcher's capabilities. Your Mastodon service specialist should have shown you how to properly operate your attachment. If you have any question regarding this, or any other Mulcher related question, please contact your Mastodon Mulcher specialist.

Warning! All operators must read and thoroughly understand this manual and its safety procedures prior to operation of this attachment.

Owner/Operator Safety

Mastodon Mulchers are designed with maximum operator safety in mind. Please familiarize yourself with the operator instructions and safety precautions. Become familiar with all controls. Keep the carrier free of debris. Only operate with a carrier that has a forestry rated Lexan glass door or comparable safety features. Travel cautiously near large objects or ditches in your machine's path.

Warning! Never Operate mulching heads within 300 feet of people or animals, falling trees and flying debris can result in injury or death.

Caution before operating the mulching head you must remove the maintenance stand, failure to do so will result on damage the mulcher





TRANSPORTING SAFELY:

The rotor must be disengaged with the deck lowered in the upright horizontal position. DO NOT LEAVE THE ROTOR ENGAGED WHILE TRANSPORTING OVER LONG DISTANCES. Proceed with caution. Anything the spinning rotor contacts will be severely damaged. The rotor should be sufficiently elevated above the terrain to prevent equipment damage.

PROCEED WITH CAUTION. Be aware of oncoming vehicles, and move slowly through uneven surfaces. Follow your typical safety precautions when driving the carrier. Do not exceed carriers balance ratio, doing so could result in flipping your machine. When transporting the head be aware of the total length the attachment adds to your machine.

Machine Shutdown:

Warning: Proper machine shut down is of the highest priority of importance, failure to adhere to shut down procedures could result in severe injury or death.

1. Disengage the auxiliary attachment hydraulics.
2. Lower the attachment to the ground.
3. Engage the carriers parking brake or place transmission in "Park".
4. Shut off engine and remove key.
5. Make certain cutting rotor has completely stopped before exiting the cab of your machine

Additional Safety Notes:

- When the rotor is turning there should not be excessive vibration. If excessive vibration occurs, turn off the mulcher immediately, follow safety precautions, and look for possible causes.
- If the hydraulic shutdown malfunctions (does not stop the rotor in 5 seconds), do not operate the Mulcher until the problem has been fixed.
- Do not exit the vehicle until the rotor has come to a complete stop.
- Always follow proper machine shut-down procedures
- Always have an exit strategy when cutting trees. Do not box yourself into a corner. When you cut, make sure you have a clear path to exit afterward.
- Do not exceed the rated gallons per minute hydraulic flow for your Mulcher. Exceeding the recommended hydraulic flow rate may cause damage to hydraulic components

HYDRAULIC REQUIREMENTS:

20-60 Gallons per minute

6,000 psi max pressure

HYDRAULIC COMPONENTS

If the hydraulic lines are leaking during operation, follow your safe maintenance precautions and re-tighten or replace hoses and fittings.

DO NOT FORGET TO CONNECT THE CASE DRAIN LINE. Failure to connect the case drain line may result in broken motor seals and motor damage



Make a visual inspection of the hydraulic lines and check for cuts, abrasions, and signs of wear.

*Remember! Follow all of your safety precautions

Make sure Carrier has the hydraulic requirements for your attachment.

Do not operate a Mastodon mulcher that has been altered in any way. An altered unit may minimize & deactivate safety features and performance.

Warning! Mastodon mulching heads UTILIZE HIGH PRESSURE HYDRAULICS: Hydraulic motors, lines, and machines can build up and carry high volumes of pressure. Hydraulic pressure can cause **serious injury**. Turn off carrier before hydraulic maintenance. Relieve pressure before unhooking hydraulic lines. Tighten all connections before applying pressure. Make sure all sleeves on external hoses are intact. Any fluid injected into the skin must be surgically removed immediately by a medical profession familiar with this type of injury. Keep all guards in place and do not operate a Mulcher that has been altered in any way.

Attaching Mulcher:

To mount the attachment to the carrier follow these instructions, failure to properly mount the attachment may result in the unit disengaging from the carrier, causing injury or death.

STEP 1: Mastodon mulching heads come equipped with a universal mounting plate. To attach the unit:

Drive the skid loader toward the plate & hook the plate with the skid loaders brackets.



- Roll the carriers brackets backwards.
- After the operator has successfully “hooked” the brackets onto the plate, the operator then engages the brackets lock function.
- The operator must then visually confirm the lock function has been successfully engaged.



Pin Locked

STEP 2: The next step is to connect the hydraulic hoses from the unit to the carrier's auxiliary ports. Every DFM attachment ships with the correct hydraulics couplers for use on the carrier specified

How to Tune Mulcher with E-Tech SmartDrive

Mastodon heads come equipped with E-tech smart drive that which allows the head to be tuned to a carrier in seconds via a smart phone app. After tuning E-tech will automatically adjusts all motor parameters to optimize performance of the attachment. After the head has been tuned it will only need to be retuned if it is switched between different skid steers.

Before using sync feature:

- Ensure mulcher is securely locked onto the skid steer and all hoses and coupler are plugged in.
- Download IQANgo from app store
- Ensure your smartphone Bluetooth is on
- Ensure the smart drive is powered up by connecting to the skid steers electrical plug and turning the skid steers on key.



Once the app has been downloaded and the smart drive is powered up tap the connect feature in the app. The smart drive will then begin to connect with the phone (this may take several seconds)

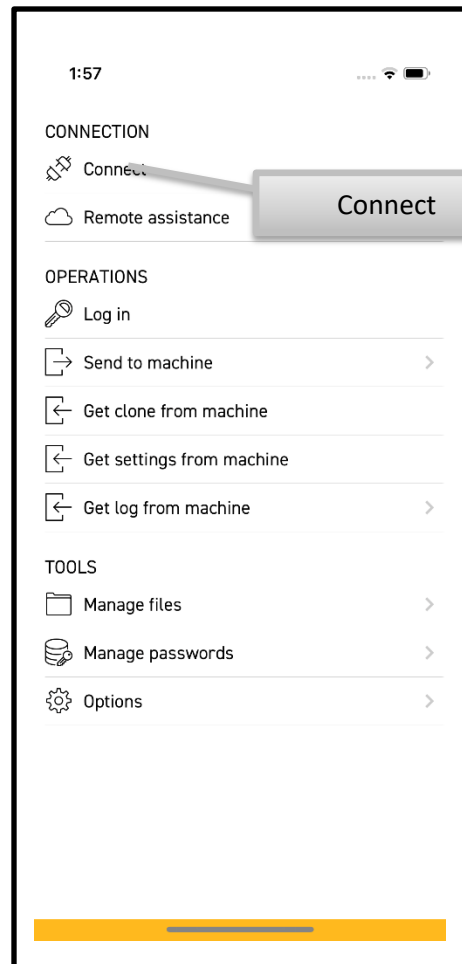

Once the connection is made there will be 5 options at the bottom of the screen. To tune the mulcher you will only use the **measure function** and the **adjust function**. It is important to understand that the **measure function is only used to measure (view) adjustments you have made in the adjust screen**

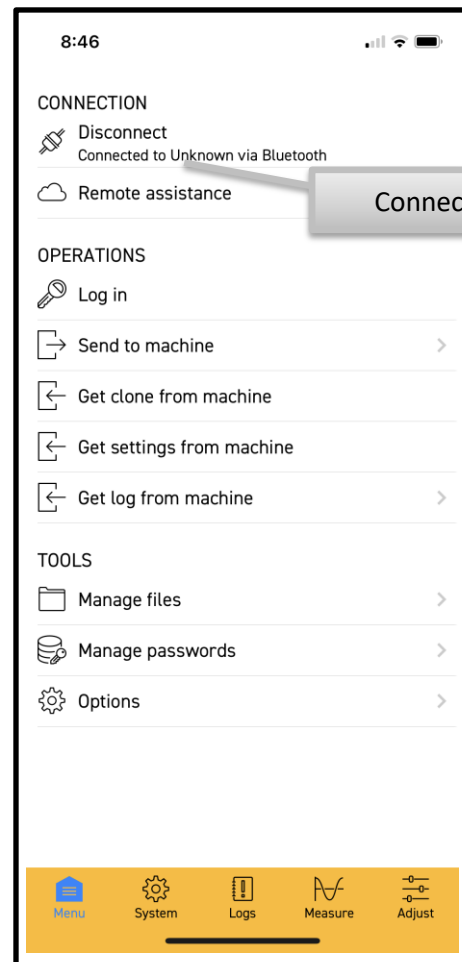
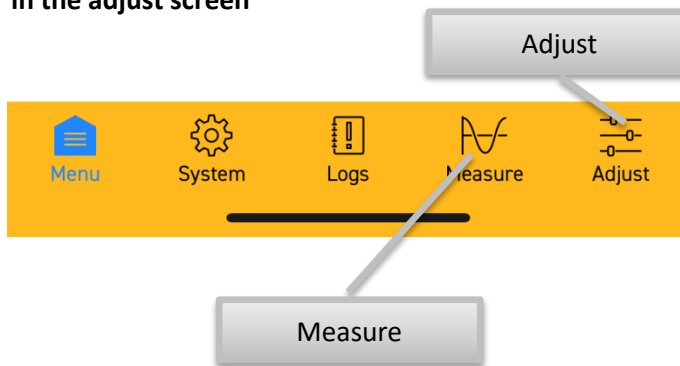

There are only two steps to tuning the head to the carrier
Step 1: Establish the skid steer GPM with the flow test feature in the app.

Step 2: Use the optimizer to set the GPM loadout to the flow displayed on the test.

Start by tapping the adjust icon on the screen this will send you to the adjustment sub-menu **fig 1**

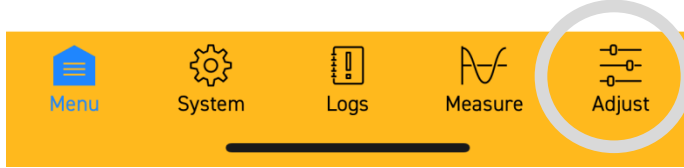

The adjustment sub-menu will have 2 options

Optimize Smart Drive allows the smart drive to be adjusted and the motor parameters synced to the skid steers GPM

Test Machine GPM allows the operator to use the GPM test function to identify the skid steers GPM

First tap the Test machine GPM and it will pull up the GPM test function

There is a toggle will have a normal mode displayed, this toggle changes to GPM test mode when swiped

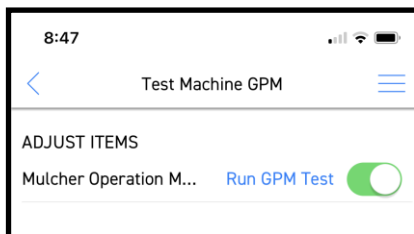

IMPORTANT NOTE: you must return toggle to normal mode after the GPM test is finished in order for head to function properly

Fig 1

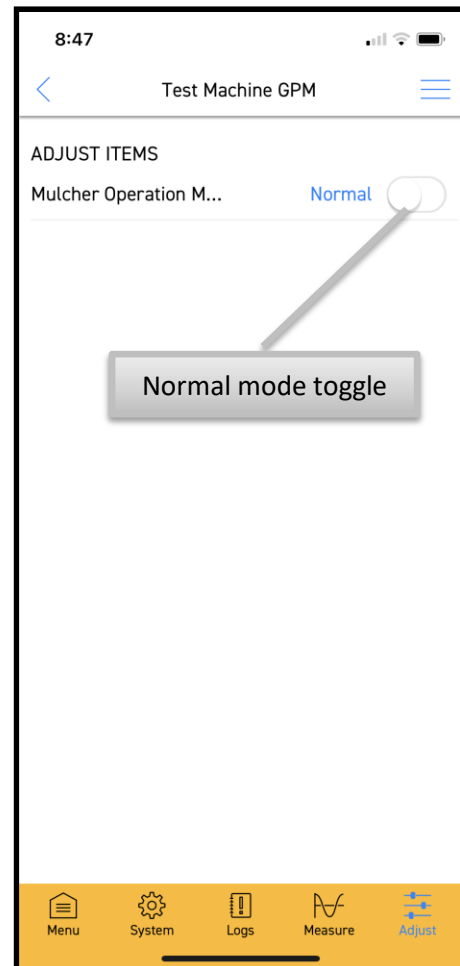
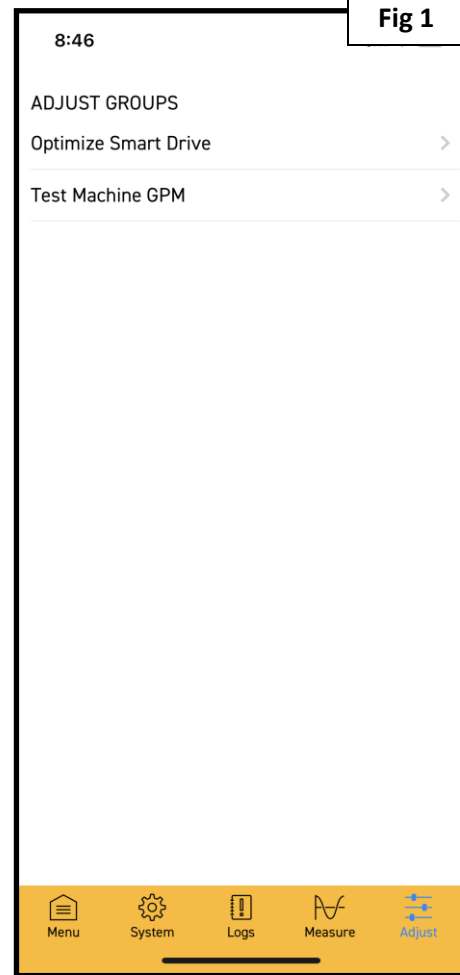

After the toggle has been switch to GPM test mode tap the measure icon at the bottom to the screen, this will take you the measure sub-menu in order to view the GPM test.

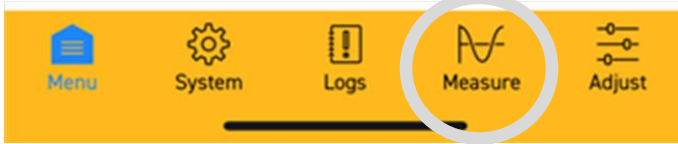

In the measure sub menu there is 3 options

RPM,PSI,Temp allows real time monitoring of Mulcher operation when in use.

Unit Data provides information on the head including hours and serial number.

GPM test allows the head to read the GPM of the skid steers hydraulic system the adjust menu has been set to test mode.



While inside the skid steer tap the GPM test and rev your skid steer to maximum throttle. At this point engage the hydraulics, the screen will now display the skid steers actual GPM as well as the current sync setting for the smart drive see **fig 2**

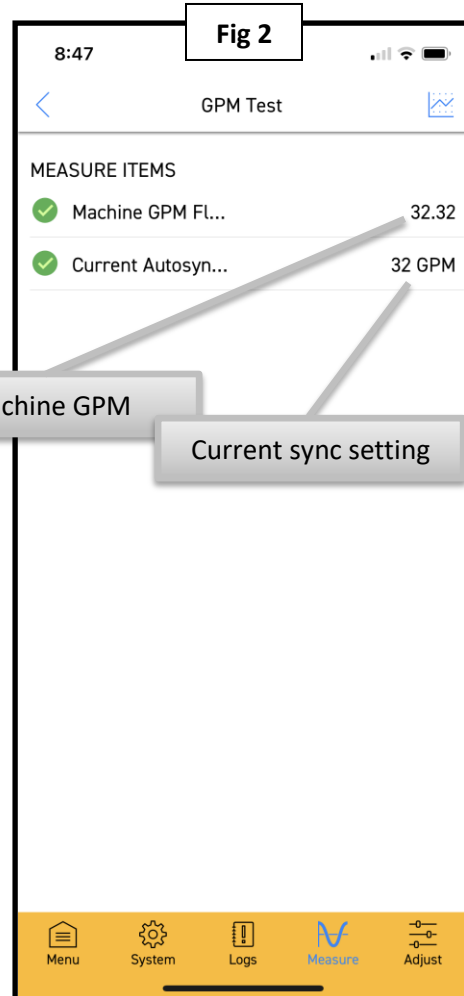
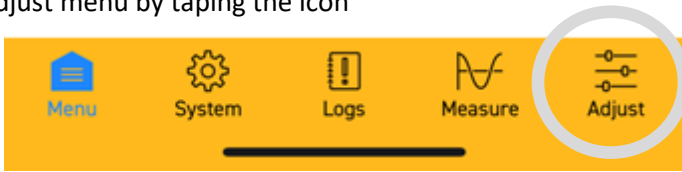

Fig 3

(You may now disengage the skid steers hydraulic). In order to complete the sync you must use the GPM value from the test as the GPM number in the auto-sync. To complete set-up first go back to the adjust menu by taping the icon



This will bring you back to the adjustment sub-menu. Before you proceed to the optimize smart drive smart drive function you must first switch the GPM test toggle back to Normal mode see fig 3

IMPORTANT NOTE: you must return toggle to normal mode after the GPM test is finished in order for head to function properly

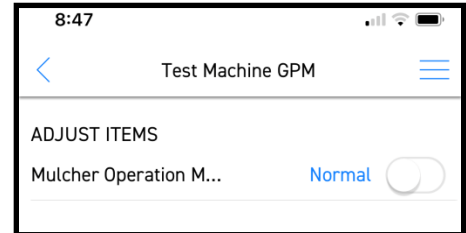
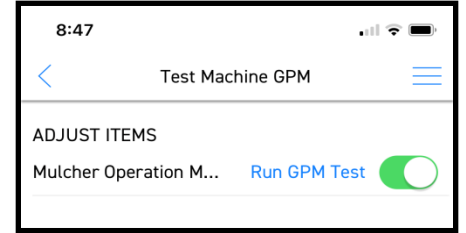
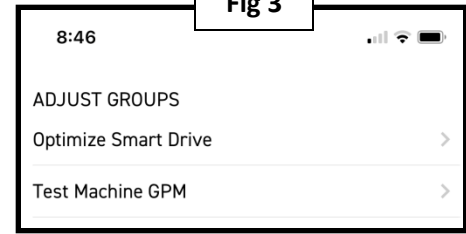

After switching back to normal mode in the GPM test menu press back arrow to pull up the adjustment sub-menu and then press the Optimize Smart Drive function, this will pull up the Optimize smart drive menu

The menu will have a single number and a drop down icon pressing and activating the dropdown will gives you access to a rolling number picker. The only requirement to sync the smart drive and tune the mulcher to the skid steer is to change the machine flow in the optimizer to reflect the number in the GPM test

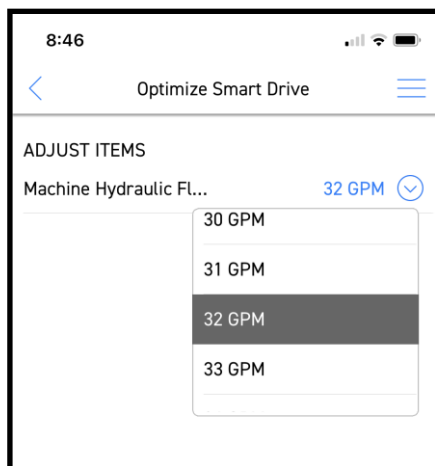

Set to GPM value from test

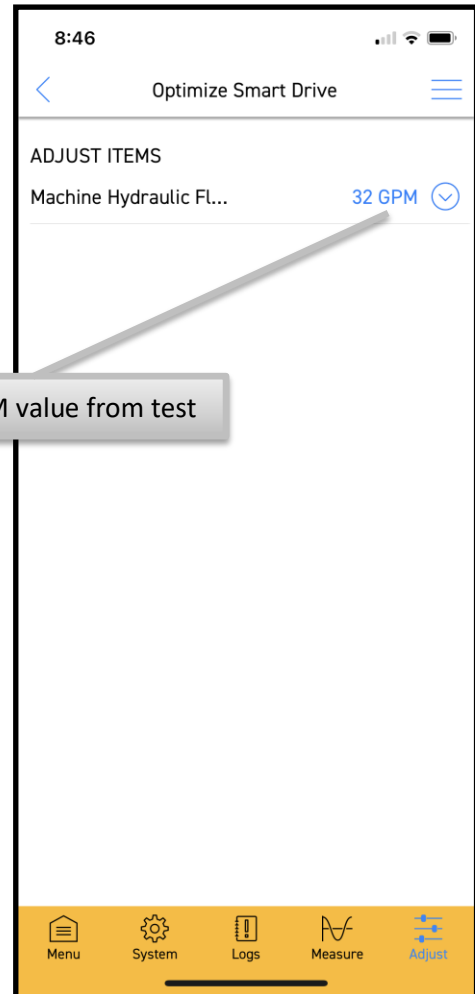

The Smart Drive is now optimized for the skid steers flow and all perimeters will be tuned automatically. In order to confirm the load out is complete and correct you can use the **RPM,PSI,Temp** monitor located in the measure menu to ensure the smart drive is functioning. When the smart drive is active the rotor RPM will read 2200-2300rpm when fully spooled.

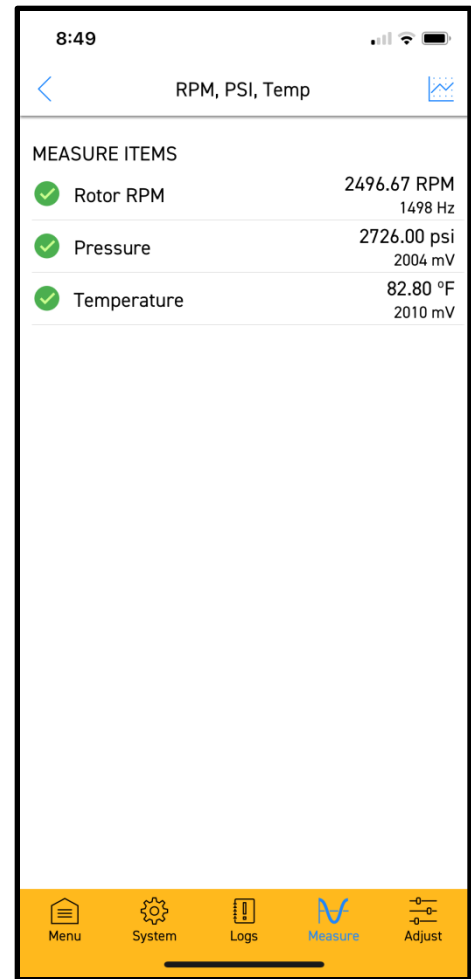

Additional unit information including total unit hours and the serial number of the head can be located in the **unit data** sub-menu of the measure menu

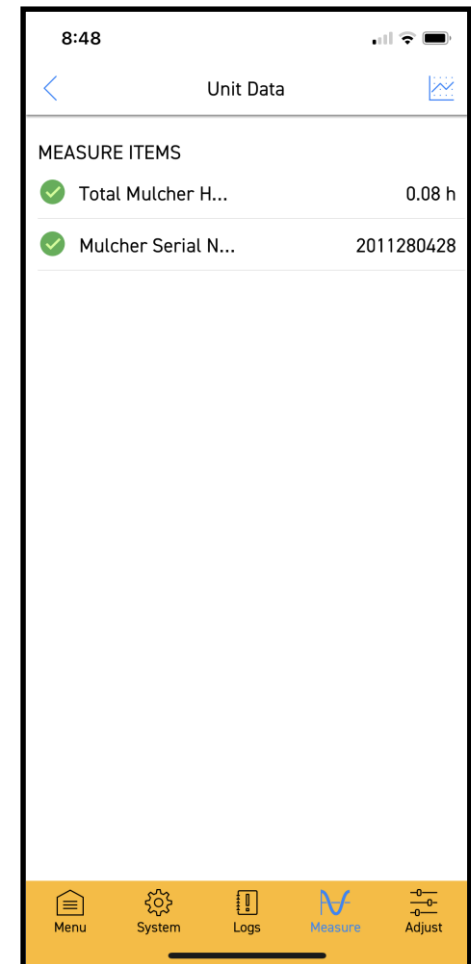

Basic Operation

Basic Operation of a Mastodon mulcher consists of 4 separate techniques. These techniques are based on material size, mulching speeds, and mulch quality. These techniques are merely an outline of the basic fundamentals of using the Mulcher. Time and experience in your specific application will ultimately determine which cutting methods work best for you.

PROPER ROTATION DIRECTION: Bottom of rotor moves toward the machine.



Startup/Shut down

Startup procedure:

1. Rev the skid steers RPM's to Maximum
2. Engage the skid steers auxiliary hydraulics
3. Allow rotor to reach peak rpm

Shut down procedure:

1. Reduce skid steer RPM's to minimal (note: do not disengage skid steer auxiliary hydraulics prior to reducing skid steer rpms)
2. Disengage the skid steers auxiliary hydraulics
3. Wait till rotor RPM's are zero and drum has come to stop

Technique 1: Felling and Mulching

This technique is effective on material 1-12" in diameter

1. The operator should be safely seated in the carrier with all necessary safety equipment in place
2. The carrier should be started and revved to maximum rpms.
3. When the desired tree is chosen the carrier should be aligned in front of the tree.
4. The skid steers hydraulic system should be engaged and the mulching rotor should be allowed to spin up to the maximum rpms.
5. As the Tree is pushed down continue to drive forward allowing the deck to cover the tree.
6. At this point the rotor will contact the base of the tree, severing the tree at ground level.
7. Continue driving over the now felled tree a steady feed rate paying close attention rotor speed and allowing the rotor enough time to mulch the material before moving forward.
8. Continue to slowly move forward over the felled tree in this manner until all the material has been processed.

Felling and Mulching



Caution: Keep deck level or tilted back unless finish mulching using technique 4. All other times do not roll deck forward; if the deck is rolled too far forward debris will be directed back to the cab of the machine. *Note: The feed rate of the unit is based on many factors including carrier size and hydraulic flow. The correct feed rate can only be determined by the operator, feeding the cutting rotor into a tree too fast will result in the rotor being unable to recover its RPMs and stalling out. If the cutting rotor stalls out back out of the tree and allow RPMS to recover.

Technique 2: “Topping and Lowering”

This technique broken up into two parts, the “Topping” and the “Lowering” This mulching method is effective on material larger than 4” in diameter or when higher quality processed material is needed

Part 1: “Topping”

1. The operator should be safely seated in the skid loader with all necessary safety equipment in place
2. The carrier should be started and revved to maximum rpms.
3. When the desired tree is chosen the carriers arms should be raised to the maximum safe height
4. The skid steers hydraulic system should then be engaged and the mulching rotor should then be allowed to spin up to the maximum rpms.
5. Once max rpms have been achieved, drive forward towards the tree slowly proceeding until the rotor makes contact with the tree.
6. As you feed the rotor into the tree at a controlled rate, use the carriers tilt to press the push bar forward into the tree; this will direct the fall of the canopy away from the carrier/operator.
7. Once the rotor has severed the canopy from the trunk you can now proceed to begin the “lowering” portion of this mulching technique.

Caution: Keep deck level or tilted back unless finish mulching using technique 4. All other times do not roll deck forward; if the deck is rolled too far forward debris will be directed back to the cab of the machine. **WARNING! YOU SHOULD NOT BE ABLE TO SEE DRUM, IF DRUM IS VISABLE MULCHER IS TILTED TOO FAR FORWARD!**

Topping:



Part 2: “Lowering”

1. Slowly begin to lower the deck onto the topped tree trunk, paying close attention and do not exceed your feed rate**
2. Continue to lower the mulching head on to the tree trunk until the entire trunk has been processed to ground level.

Lowering:



***Note:** The maximum safe operational height of the carrier's loader arms is dependent on many factors including but not limited to the carriers lifting capacity, terrain composition, and the maximum safe operational incline specified in you carriers manual.

****Note:** The feed rate of the unit is based on many factors including carrier size and hydraulic flow. The correct feed rate can only be determined by the operator, feeding the cutting rotor into a tree too fast will result in the rotor being unable to recover its RPMs and stalling out. If the cutting rotor stalls out back out of the tree and allow RPMS to recover.

Technique 3: Brush Pile/Topped Canopy/Downed Limb Mulching

This Technique is effective for general mulching of material that is laying at ground level

1. The operator should be safely seated in the carrier with all necessary safety equipment in place
2. The carrier should be started and revved to maximum rpms.
3. When the desired material is chosen the carrier should be aligned in front of the downed material.
4. The carriers arms should be positioned to allow the back of the mulcher frame to be raised just clear of ground level
5. The operator should then use the carriers tilt to raise the front of the mulcher upward to around a 45 degrees, this will allow larger material and limbs to be forced into the rotor for processing.
6. The skid steers hydraulic system should then be engaged and the mulching rotor should then be allowed to spin up to the maximum rpms.
7. Once max rpms have been achieved, the carrier should then be moved forward slowly, allowing the material travel into the frame opening and come in contact mulching rotor.
8. Once the mulcher rotor have begun to process the material, stop the carries forward movement and use the carries tilt to press the rotor downwards onto the material at a steady feed rate.
9. Continue to tilt feed the rotor into the material, paying close attention to the rotor speeds, until the deck has gone from a 45 degree angle to level.
10. At this point the material under the rotor has been completely processed and you are ready to begin the mulching cycle again.
11. Reset the deck to a 45 degree angle drive the carrier forward and begin the process again.
12. Continue driving over the material in this manner paying close attention to the rpm gauge and allowing the rotor enough time to mulch the material before moving forward.

13. After the rotor of the mulcher has passed the entire length of the downed material use the carriers arms to raise the entire mulcher deck up 2 to 3 feet off the ground, back the carrier up far enough to reveal the entire length of the material processed.
14. If any material has been left unmulched, lower the deck to just above ground level and drive the carrier forward for a final finish mulching pass.

Caution: Keep deck level or tilted back unless finish mulching using technique 4. All other times do not roll deck forward; if the deck is rolled too far forward debris will be directed back to the cab of the machine.

Technique 4: Finish Mulching/Mulch Tilling

This Technique is effective for re-mulching of material that is laying at ground level or to till the mulched material into the ground in site prep applications.

Note: Mulch tilling greatly reduces the life expectancy of the carbide cutting edges, and drum components, it is not recommended to mulch into rocky soil, or soil with the possibility of hidden objects.

1. The operator should be safely seated in the carrier with all necessary safety equipment in place
2. The mulched material should already processed to ground level
3. The carrier should be started and revved to maximum rpms.
4. The carriers arms should be positioned to allow the back of the mulcher deck to be raised just clear of ground level.
5. The operator should then use the carriers tilt to lower the front of the mulcher frame downwards so the mulcher rotor is raised just clear of ground level.
6. The skid steers hydraulic system should then be engaged and the mulching rotor should then be allowed to spin up to the maximum rpms.
7. Once max rpms have been achieved, the carrier arms should be lowered slightly to allow rotor to just touch the top surface of the ground.
8. The Carrier should then move backward slowly, allowing the material and soil to travel under the frame and come in contact mulching rotor.

9. Continue to make passes in this manner until all material has been processed and tilled into the ground.



UNPLUGGING MATERIAL CLOGGED ROTOR/DECK:

In the event that too much material is fed into the rotor too quickly, debris may become clogged in-between the rotor and the breaker plate; binding out the rotor and causing it to stall out.

This is normal and will happen on occasion.

To unclog your mulcher, you have two options:

Option 1: disengage the machines hydraulics and activate REVERSE on the hydraulic supply, do this only long enough to remove the clog completely. **DO NOT** attempt to operate mulching functions in reverse; this will cause damage to the rotor. This option works well if the clog is not very severe.

Option 2: In the case of severe clogs, disengage the carrier's hydraulics, and locate a suitable stump/tree/log to use as an anchor. Using the carriers lift arms lower the mulcher down onto the anchor until the rotor makes contact and is pressing against the anchor.

At this point back up the carrier, allowing the carrier's rearward movement to reverse the rotor against the anchor, clearing the clog.

Trouble Shooting:

Problem: The mulcher rotor is not rotating very fast

Solution:

- Check and make sure your machines high-flow is on, and your machines throttle is revved up to full RPMs.
- Check the sync status on the monitor, confirm the loadout is correct for your skid steer

Problem: The Smart drive is not connecting to phone

Solution:

- Make sure your phones Bluetooth is on
- Make sure that you are under 10 ft. away from the head
- Make sure your carrier is powering the head

Problem: The mulcher is leaking fluid out the left side under hose protection cover

Solution: Check your case drain line. The Mastodon heads require a case drain to relieve excesses pressure, if the case drain comes unplugged or the line gets crushed, the mulcher has a built in pop off valve that protects the motor, this valve allows the excesses fluid to leak out of a weep hole located under the hose protection cover

Problem: I bought my mulcher for one brand of skid steer and now I have a new skid steer from another brand; will the mulcher work on both?

Solution: Smart drive heads can be switched between most carriers by re-synching smart drive.

Problem: Skid steer is running hot

Solution:

- Confirm that the Smart drive loadout reflects your skid steers pressure and flow.
- Check your skid steers hydraulic coolers and clean out any debris

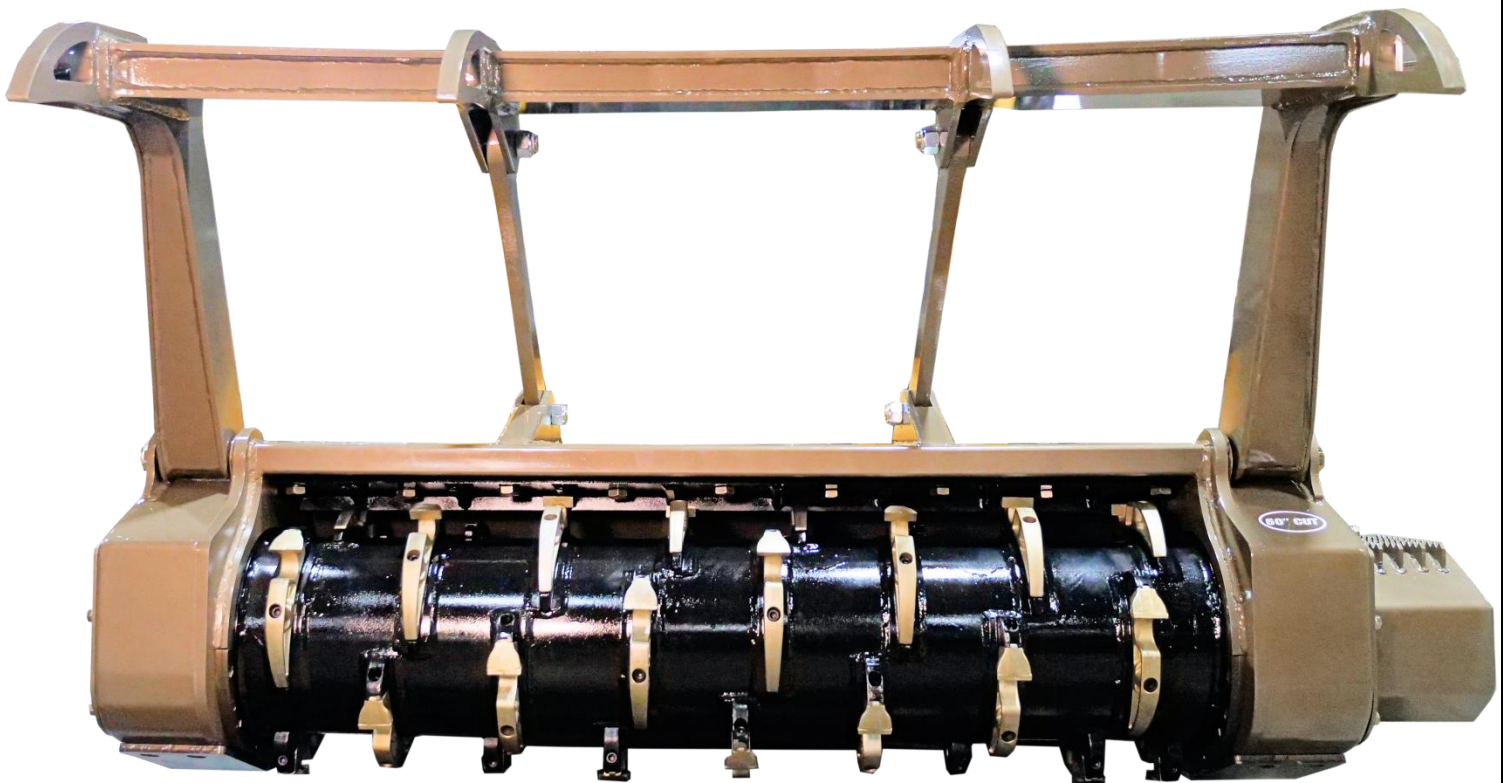

Dougherty Forestry Manufacturing LTD. CO.

3901 E HWY 66 EL Reno, 73036 OK

Phone: (405) 562-7376